

**BOLT DOWN
DETAIL**

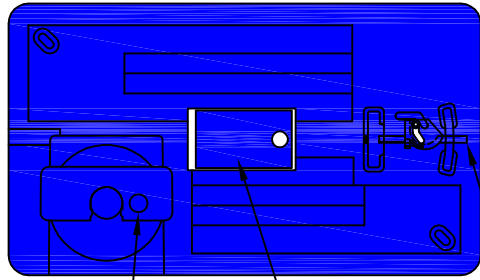

60W ITRON MOUNT
CAST IRON READER DOOR

DFW-BLOCK-XL

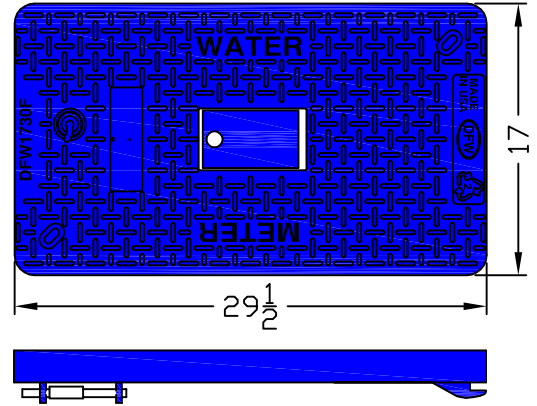

DFW1730F-3DCSA-LID

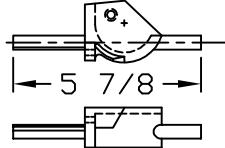

DFW-SBLOCK-XL

**OPTIONAL
SECURITY
HARDWARE**



**DFW-SBOLT
INSTALLED**



DFW-SDRIVER



DFW-SBOLT

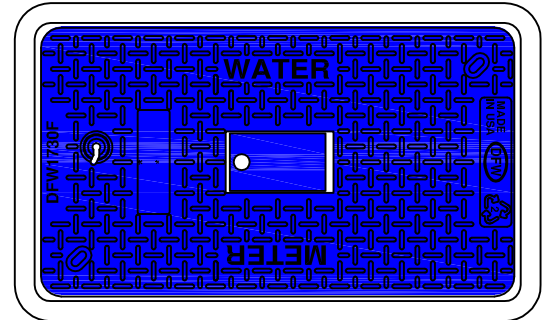
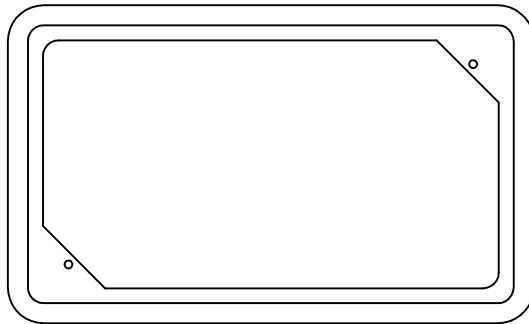

DFW1730F-24-3DCSA

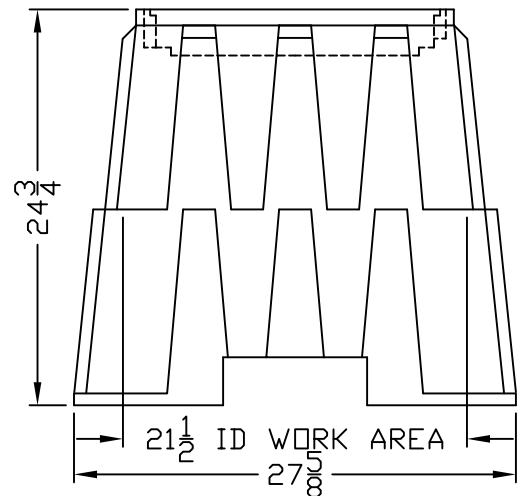
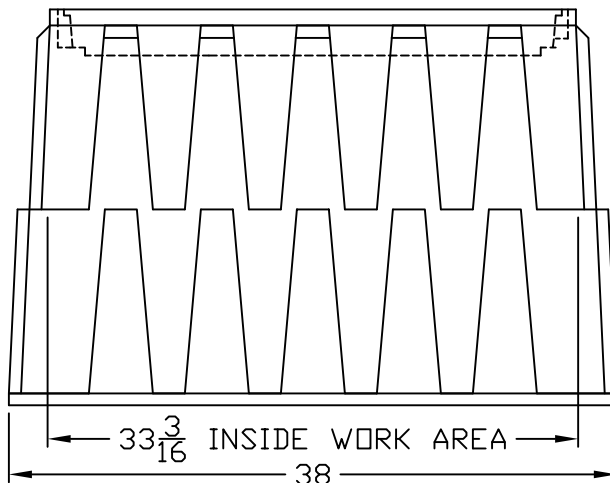

DFW1730F-24-BODY

NOTES

- 1) DIM'S ± 1/8
- 2) WALL THICKNESS: 3/8 ± 5%
- 3) SNAP LOCK POCKET WILL RECEIVE AMR/AMI DEVICE ERT. SNAP LOCK SLOT IS 1.80" ± .015" TO ALLOW FOR A FINGER FORCE INSTALL. POCKET HEIGHT IS 15/16 FOR MIN 1/8" AIR GAP.



DFW PLASTICS, INC.
1001 JARVIS RD
FORT WORTH, TX. 76179
(817) 439-3600
(817) 439-3700 (f)
www.dfwplasticsinc.com

DFW1730F-24-3DCSA

FILE NAME:

*
*

UPDATED: 10/05/2010

DRAWN BY: J.C.A.

PLOT SCALE: 1:12