

DFW-SBLOCK-XL

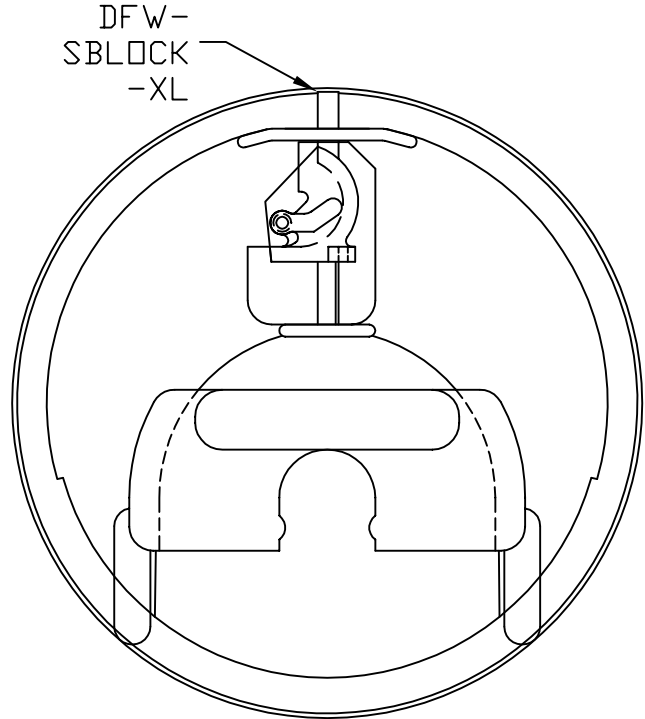
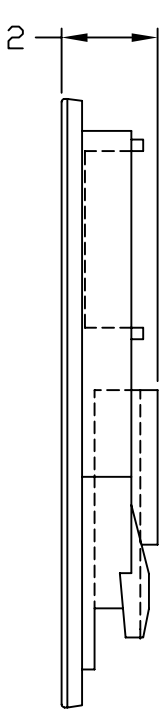
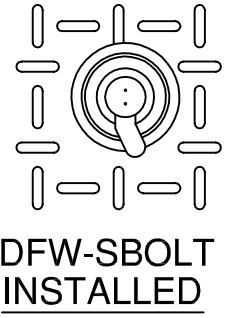
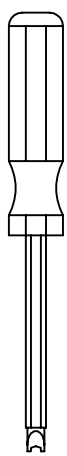
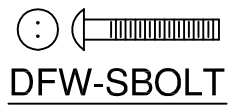
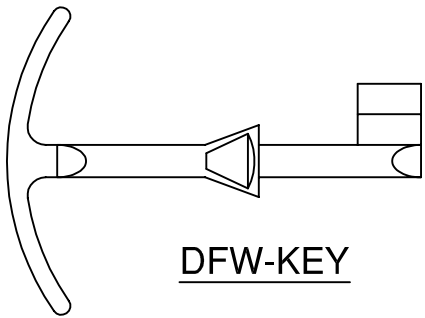
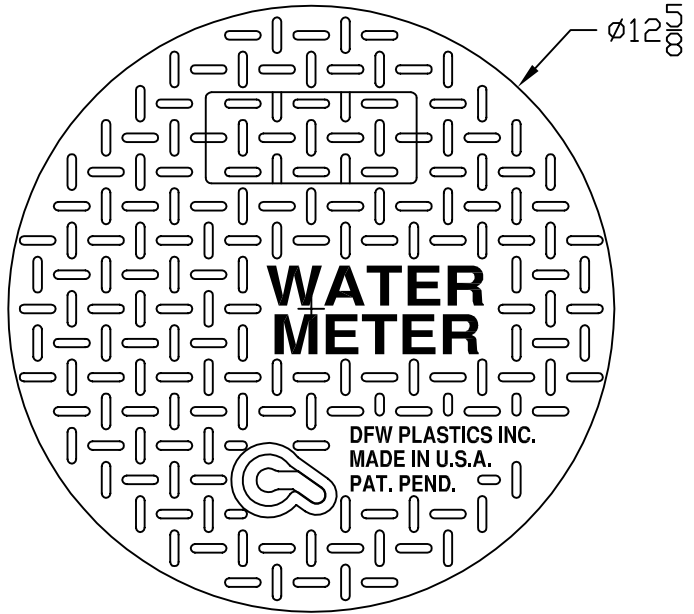

OPTIONAL SECURITY HARDWARE

NOTES

- 1) DIM'S ± 1/8 U.N.O.
- 2) SNAP LOCK POCKET WILL RECEIVE AMR/AMI DEVICE ERT. SNAP LOCK SLOT IS 1.80" ± .015" TO ALLOW FOR A FINGER FORCE INSTALL. POCKET HEIGHT IS 15/16 FOR MIN 1/8" AIR GAP.



DFW PLASTICS, INC.
1001 JARVIS RD
FORT WORTH, TX. 76179
(817) 439-3600
(817) 439-3700 (f)
www.dfwplasticsinc.com

DFW18AMR-1SA-LID

FILE NAME: * DFW18AMR-1SA-LID.DWG
UPDATED: 02/04/2010
DRAWN BY: J.C.A.
PLOT SCALE: 1:4