

TAPPED HOLD

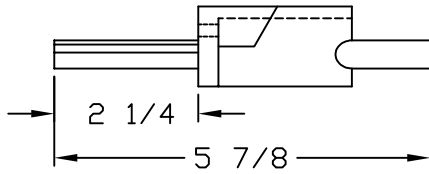

DFW-SBLOCK-XL

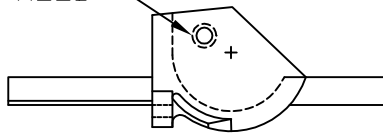
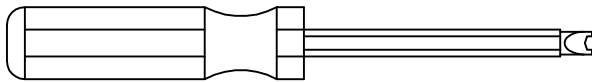

DFW-SDRIVER

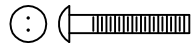

DFW-SBOLT

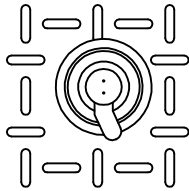

DFW-SBOLT INSTALLED

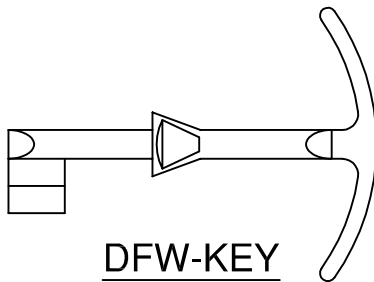

DFW-KEY

Ø6 1/2 x 1/4 DEEP RECESS FOR AMR PAD w/ Ø1 7/8 KNOCK OUT SLUG FOR OPTIONAL TOUCH READ HOLE

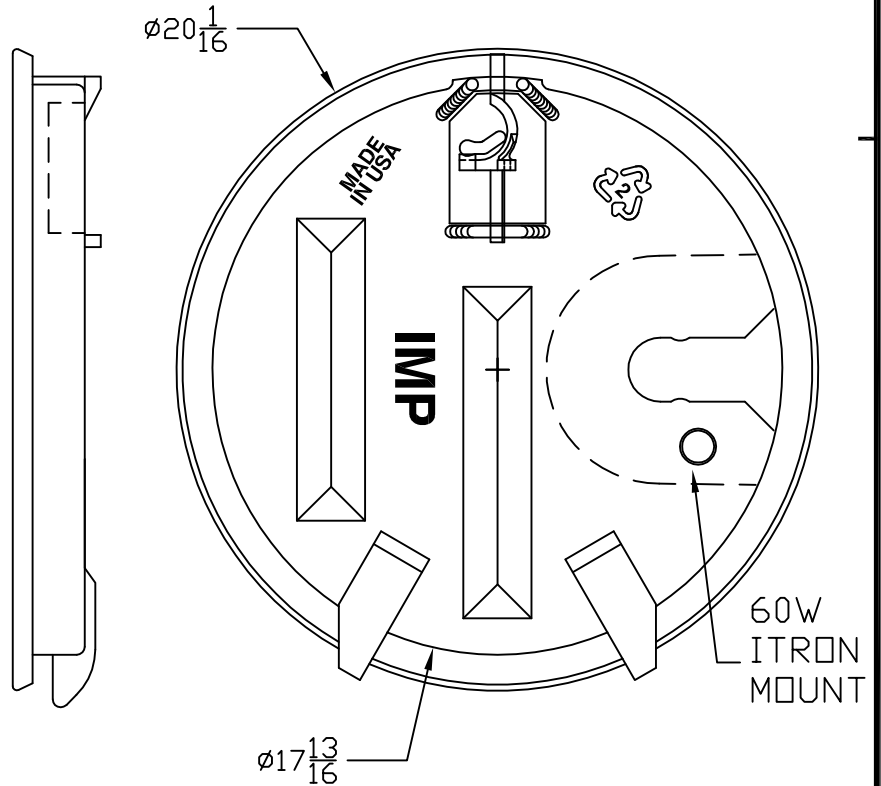
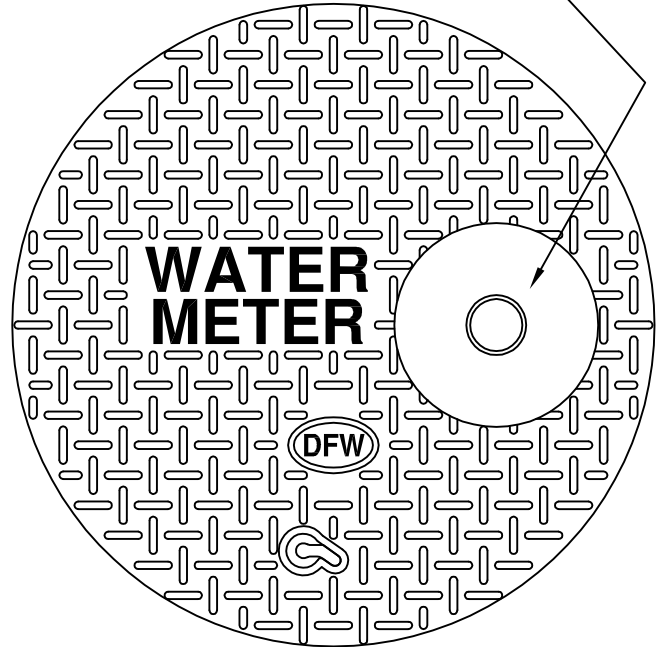

NOTES

- 1) DIM'S ± 1/8 U.N.O.
- 2) DESIGNED FOR IMPORT CAST IRON RING.
- 3) SNAP LOCK POCKET WILL RECEIVE AMR/AMI DEVICE ERT. SNAP LOCK SLOT IS 1.80" ± .015" TO ALLOW FOR A FINGER FORCE INSTALL. POCKET HEIGHT IS 15/16 FOR MIN 1/8" AIR GAP.



DFW PLASTICS, INC.
1001 JARVIS RD
FORT WORTH, TX. 76179
(817) 439-3600
(817) 439-3700 (f)
www.dfwplasticsinc.com

DFW20AMRI-1SAF ITRON-LID

FILE NAME:
* DFW20AMRI-1SAF-LID.DWG
UPDATED: 09/07/2010
DRAWN BY: J.C.A.
PLOT SCALE: 1:6