

DFW1730F-1-LID

LID KEY	
1	BLACK COLOR

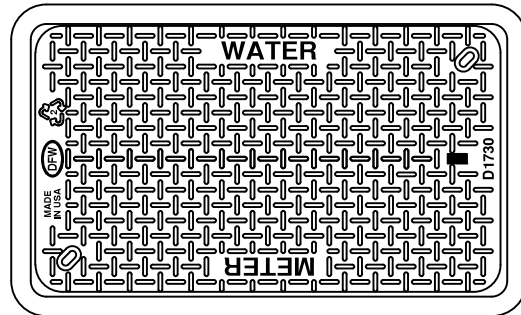

DFW1730F-24-1

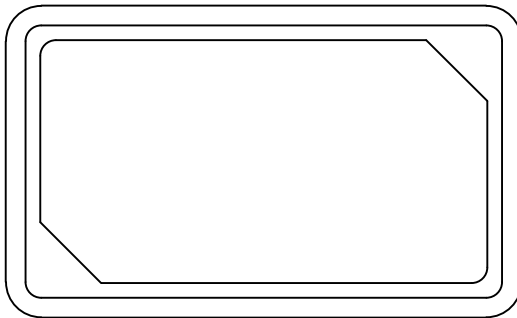
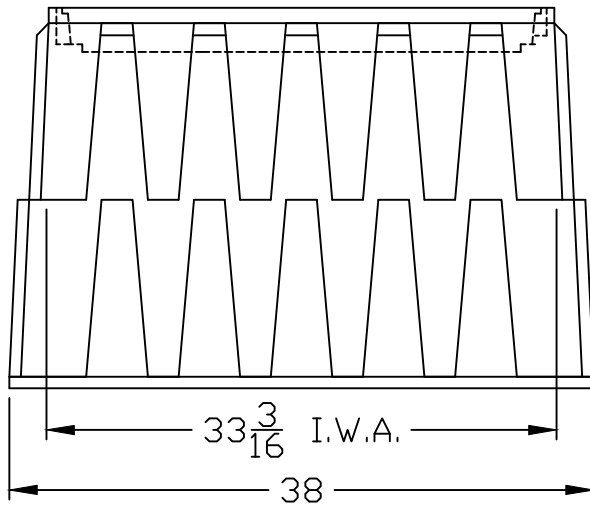

DFW1730F-24-BODY

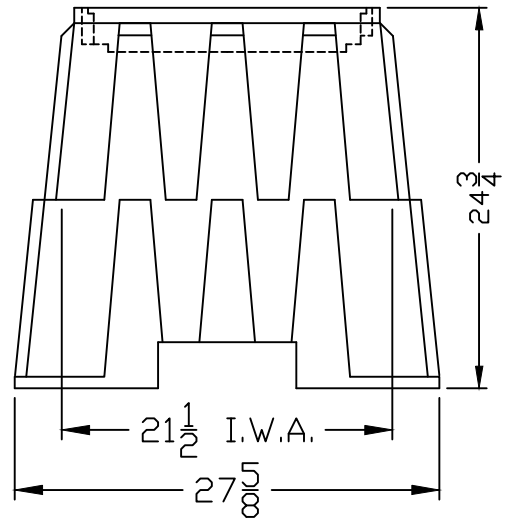

NOTES

- 1) DIM'S ± 1/8" U.N.O.
- 2) LID MATERIAL: HDPE
- 3) BODY MATERIAL: LLDPE
- 4) WALL THICKNESS: 3/8" ± 5%
- 5) I.W.A. = INSIDE WORK AREA

DFW PLASTICS, INC. ENGAGES IN ONGOING RESEARCH AND DEVELOPMENT TO IMPROVE AND ENHANCE ITS PRODUCTS. THEREFORE, DFW PLASTICS, INC. RESERVES THE RIGHT TO CHANGE PRODUCT OR SYSTEM SPECIFICATIONS WITHOUT NOTICE.



DFW PLASTICS, INC.
PO BOX 648
BEDFORD, TEXAS 76095
(817) 439-3600
(817) 439-3700 (f)
www.dfwplasticsinc.com

DFW1730F-24-1

CREATED: 03/31/2014

UPDATED: 03/31/2014

ACCEPTED: JMc

DRAWN BY: RMc

PLOT SCALE: 1:12